

# 3DO Blaster User's Guide

---

Information in this document is subject to change without notice and does not represent a commitment on the part of Creative Technology Ltd. The software described in this document is furnished under a license agreement and may be used or copied only in accordance with the terms of the license agreement. It is against the law to copy the software on any other medium except as specifically allowed in the license agreement. The licensee may make one copy of the software for backup purposes. No part of this manual may be reproduced or transmitted in any form or by any means, electronic or mechanical, including photocopying and recording, for any purpose without the written permission of Creative Technology Ltd.

Copyright 1994 by Creative Technology Ltd. All rights reserved.  
Printed in Singapore.

Version 1.0  
September 1994

3DO Blaster, Sound Blaster Pro, Sound Blaster 16, Sound Blaster Advanced WavEffects 32, and VoiceAssist are trademarks of Creative Technology Ltd.  
3DO and the 3DO logo are trademarks of The 3DO Company.  
IBM and PS/2 are registered trademarks of International Business Machines Corporation.  
MS-DOS is a registered trademark and Windows is a trademark of Microsoft Corporation.  
All other products are trademarks or registered trademarks of their respective owners.  
This product contains a font derived from the JIS 9051 font set licensed from the Japanese Standards Association.

---

## FCC Notice

This device has been tested and found to comply with the limits for a Class B digital device, pursuant to Part 15 of the FCC Rules. These limits are designed to provide reasonable protection against harmful interference in a residential installation. This device generates, uses, and can radiate radio frequency energy and, if not installed and used in accordance with the instruction, may cause harmful interference to radio communications. However, there is no guarantee that interference will not occur in a particular installation. If this device does cause harmful interference to radio or television reception, the user is encouraged to try to correct the interference by one or more of the following measures:

- Reorient or relocate the receiving antenna.
- Increase the separation between the computer and receiver.
- Connect the computer into an outlet on a circuit different from that to which the receiver is connected.
- Consult the dealer or an experienced radio/TV technician for help.

FCC ID : IBACT-MMU3DO

---

## CAUTION

To comply with the limits for the Class B digital device, pursuant to Part 15 of the FCC Rules, this device must be installed in computer equipment certified to comply with the Class B limits. **All cables used to connect the computer and peripherals must be shielded and grounded.** Operation with non-certified computers or non-shielded cables may result in interference to radio or television reception.

---

## MODIFICATIONS

Any changes or modifications not expressly approved by the grantee of this device could void the user's authority to operate the device.

---

## Contents

Introduction .....	vi
Before You Begin .....	vi
Checking System Requirements .....	vi
Obtaining Latest Information .....	vii
Making a Copy of Your Diskettes .....	vii
Using this Guide .....	vii
Document Conventions .....	ix

## Knowing Your 3DO Blaster

Cables .....	1-1
VGA Loopback Cable .....	1-2
VGA Feature Connector Cable .....	1-2
CD Audio Cables .....	1-3
Connectors .....	1-3
CD-ROM Data Connector .....	1-3
CD Audio-In Connector .....	1-4
CD Audio-Out Connector .....	1-4
VGA Feature Connector .....	1-4
VGA In Connector .....	1-4
VGA Out Connector .....	1-4
3DO Control Port .....	1-4
FMV Daughterboard Connector .....	1-4
Jumpers .....	1-5
Identifying the Base I/O Address Jumper .....	1-6
Knowing the Base I/O Address Jumper Setting .....	1-7

## Setting Up Your Hardware

Installing Your 3DO Blaster .....	2-1
Connecting Your 3DO Blaster to Creative CD-ROM Drive .....	2-6
Connecting Your 3DO Control Pad to Your 3DO Blaster .....	2-8
Connecting Your 3DO Blaster to Other Devices .....	2-9
Connecting Your 3DO Blaster to Audio Card .....	2-9
Connecting Your 3DO Blaster to VGA Card .....	2-10
Connecting Your 3DO Blaster to VGA Monitor .....	2-12

## Setting Up Your Software

Setting Up 3DO Blaster Software .....	3-1
Using the 3DO Blaster Configuration Utility .....	3-5

## Using 3DO Player

Starting 3DO Player .....	4-2
Knowing the 3DO Player Window .....	4-2
Control Menu .....	4-3
Player Screen .....	4-3
Status Bar .....	4-3
Menu Bar .....	4-3
File Menu .....	4-3
View Menu .....	4-4
Emulation Menu .....	4-4
Control Menu .....	4-5
Help Menu .....	4-5
Tool Bar .....	4-6
Starting a 3DO Title .....	4-7
Controlling a 3DO Title .....	4-7
Using Your 3DO Control Pad .....	4-8
Using Your Keyboard .....	4-9
Using Your Joystick .....	4-10
Using Your Voice .....	4-11
Customizing 3DO Player .....	4-13
Resizing the 3DO Player Window .....	4-13
Changing Screen Modes .....	4-14
Changing Color Key .....	4-15
Changing Overlay Display Mode .....	4-16
Adjusting Volume .....	4-18
Saving a Title .....	4-19
Quitting 3DO Player .....	4-20

## Changing 3DO Blaster Hardware Setting

Changing Jumper Configuration .....	5-1
Changing Base I/O Address Jumper Setting .....	5-3

## Appendices

- A Using 3DO Video Overlay Setup
- B Troubleshooting Guide
- C Technical Support
- D 3DO Blaster General Specifications

## Index

---

## Introduction

Welcome to the next generation of entertainment on the PC.

3DO Blaster and 3DO Player transform your PC into the ultimate game machine. Utilizing The 3DO Company's revolutionary 32-bit graphics technology, 3DO Blaster will allow your computer to play any 3DO title. You can now have all the fun on your computer that previously only standalone 3DO sets could give.

This guide will help you install and configure your 3DO Blaster in your computer. Read and follow its instructions for trouble-free installation and use.

---

## Before You Begin

Before you begin setting up the contents in your package, you should read the following:

- Checking System Requirements
- Obtaining Latest Information
- Making a Copy of Your Diskettes
- Using this Guide
- Document Conventions

---

## Checking System Requirements

You need to verify that your system meets the following requirements:

- IBM 386SX, 386, 486, Pentium, or 100% compatibles
- Creative Labs CR-563 double speed CD-ROM drive
- 2 MB free hard disk space (minimum)
- VGA monitor
- VGA card with VESA compatible feature connector
- Sound Blaster Pro, Sound Blaster 16, or Sound Blaster AWE32
- Speakers
- 16-bit ISA expansion slot
- Windows version 3.1

---

## Obtaining Latest Information

The README file in the installation diskette contains the latest information and changes not available at the printing time of this manual. Please read this file when prompted to during software installation.

---

## Making a Copy of Your Diskettes

If you have not made a copy of the original diskettes that came with your package, you should do so before installing the software in your system. Store your original diskettes in a dry and cool environment.

---

## Using this Guide

This User's Guide is designed so that you can install and begin using 3DO Blaster in the quickest way possible.

If you are new to 3DO Blaster or peripheral cards, read Chapter 1 in detail to orientate yourself with the components of 3DO Blaster.

Once you have the information in the first chapter, you can go on to Chapters 2 and 3 to install the hardware and software from your package. During installation, you may need to read Chapters 5 to change certain hardware settings of your 3DO Blaster for it to work in your particular computer.

After the hardware and software have been installed properly, you can read Chapter 4 to begin playing your 3DO titles.

The following are brief descriptions of each chapter:

### Chapter 1 "Knowing 3DO Blaster"

This chapter contains information on the connectors and jumpers of your 3DO Blaster. Read this chapter to find out what they are and what they are used for.

### Chapter 2 "Setting Up Your Hardware"

Information on how to install 3DO Blaster is found in this chapter. Read and follow the instructions provided here carefully when you install this item in your computer.

### Chapter 3 “Setting Up Your Software”

This chapter tells you how to install the software from your package. Read it to find out how to use the Windows installation utility and configuration program that come with the installation diskette.

### Chapter 4 “Using 3DO Player”

Instructions on how to start and use this software application that plays your 3DO titles are found in this chapter. Read it completely to make full use of the 3DO Player.

### Chapter 5 “Changing 3DO Blaster Hardware Settings”

The information contained in this chapter helps you to change the base I/O address hardware setting of your 3DO Blaster. Read this chapter only if you have a hardware conflict between your 3DO Blaster and another peripheral card in your computer.

### Appendix A “Using 3DO Video Overlay Setup”

If you encounter problems displaying images from your 3DO titles, read this chapter for information on how to use the 3DO Video Overlay Setup utility to correct the problems.

### Appendix B “Troubleshooting Guide”

Information contained in this appendix will help you to troubleshoot common problems that you may encounter when you install or use 3DO Blaster. If you have a problem, look in here for a solution before calling our technical support.

### Appendix C “Technical Support”

This appendix lists our contact numbers and addresses for you to call or write to if you have any questions or comments about your 3DO Blaster. Refer to these numbers and addresses if you cannot find a solution to your problem in the Troubleshooting Guide in Appendix B.

### Appendix D “General Specifications”

Detailed specifications of your 3DO Blaster are provided in this appendix. Read this appendix for more information about the hardware in your package.

---

## Document Conventions

The information in this guide follows certain conventions that are adopted to help you locate and identify the information. These conventions provide consistent text formats and cues, and are designed to ensure that information is easily identifiable.

The conventions are:

<i>italics</i>	Variable quantities that are not fixed and which you can change.
<KeyName>	Names of keys on your keyboard.
ALL CAPS	Directory names, filenames, and acronyms.
<b>BOLD CAPS</b>	Commands, switches or parameters, and text that must be typed exactly as they appear.

Additionally, the symbol  is used to denote an area of text where information or instructions must not be taken lightly but should be noted or followed.

---

## Knowing Your 3DO Blaster

This chapter helps you locate and identify the components of your 3DO Blaster. The components of your card are divided into the following categories:

- Cables
- Connectors
- Jumpers

---

### Cables

Cables are wires with connectors at both ends. They connect your 3DO Blaster to other devices and help transport signals between your 3DO Blaster and other devices. They make essential connections for your 3DO Blaster to work properly.

The cables supplied with your 3DO Blaster are shown in Figures 1-1, 1-2, and 1-3.



Figure 1-1: VGA Loopback cable.

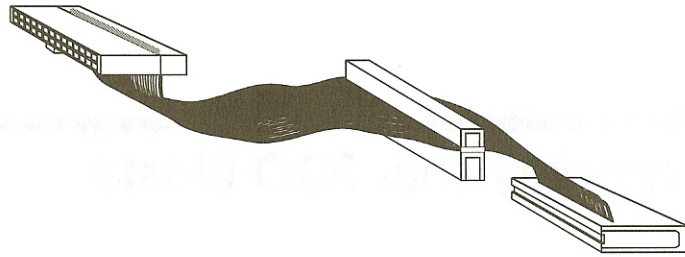

Figure 1-2: VGA Feature Connector cable.

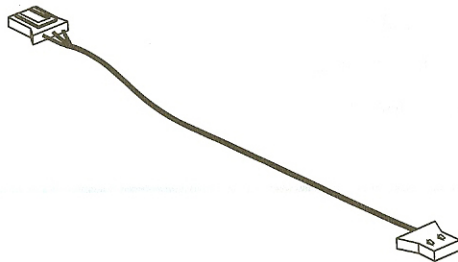

Figure 1-3: CD Audio cable.

## VGA Loopback Cable

The VGA Loopback cable connects your VGA card to your 3DO Blaster. It has male 15-pin D-Shell connectors at each end that join with the female connectors of your VGA card and 3DO Blaster.

## VGA Feature Connector Cable

The VGA Feature Connector cable connects your 3DO Blaster's VGA Feature connector to your VGA card's VGA Feature connector. It has a slot connector and a 26-pin female connector at one end and another 26-pin female connector at the other end. This cable carries necessary digital signals from the VGA card for your 3DO Blaster to work.

## CD Audio Cables

The two CD Audio cables supplied are identical. They are used for carrying audio signals from your Creative CD-ROM drive to your 3DO Blaster and to your audio card. Without them, audio from your CD cannot be heard.

## Connectors

Connectors, or ports as they are also called, are connecting interfaces consisting of many pins that allow you to attach other devices to it.

There are several connectors on your 3DO Blaster. They are found on the card's surface and its rear panel. The connectors on your card are shown in Figure 1-4.

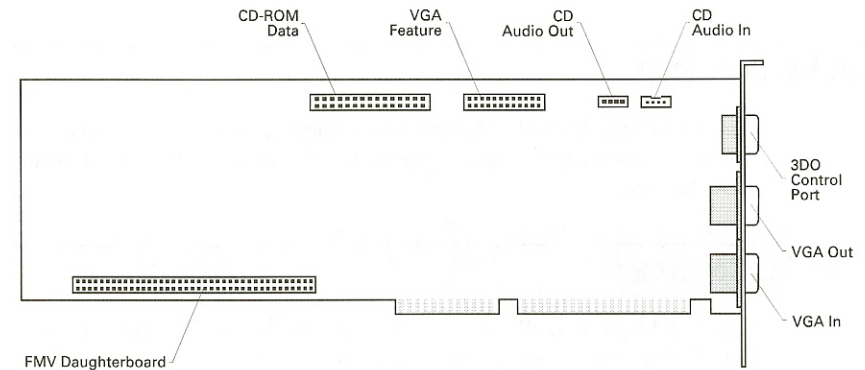

Figure 1-4: The connectors on your 3DO Blaster.

The following sections describe the purpose of each connector.

## CD-ROM Data Connector

The CD-ROM Data connector allows you to connect your 3DO Blaster to a Creative CD-ROM drive using a CD-ROM Data cable. Detailed instructions are provided in Chapter 2.

---

## CD Audio-In Connector

The CD Audio-In connector allows you to connect the audio output from a Creative CD-ROM drive to your 3DO Blaster. This connector will enable your 3DO Blaster to obtain audio from CDs.

---

## CD Audio-Out Connector

The CD Audio-Out connector allows you to connect the audio output from your 3DO Blaster to your audio card. This connection lets your 3DO Blaster send audio signals to your audio card.

---

## VGA Feature Connector

This is a 26-pin connector that connects to your VGA card via the VGA Feature Connector cable. When connected, digital VGA signals can be sent from the VGA card to your 3DO Blaster.

---

## VGA In Connector

This is a 15-pin D-shell connector that connects to your VGA card via the VGA Loopback cable. When connected, VGA signals can be sent to your 3DO Blaster.

---

## VGA Out Connector

This is a 15-pin D-shell connector that connects to the VGA monitor via the VGA monitor's cable. When connected, analog VGA signals can be sent to the VGA monitor.

---

## 3DO Control Port

This is a 9-pin D-shell connector that connects to a 3DO control pad. When connected, you can use the control pad to control your 3DO title.

---

## FMV Daughterboard Connector

This connector allows for future upgrades.

---

## Jumpers

A jumper is a group of pins that you can configure to define a hardware setting of your 3DO Blaster (see Figure 1-5). For example, you can use a jumper to set a different base I/O address for your 3DO Blaster.

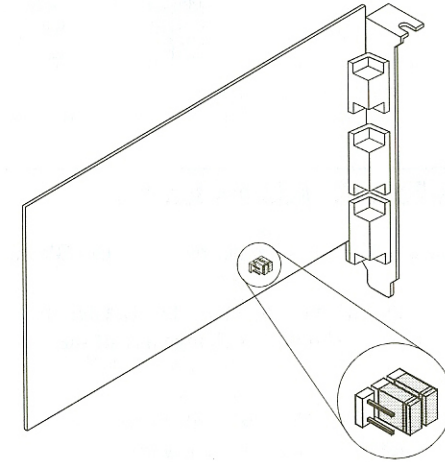

Figure 1-5: A jumper.

The jumpers found on your 3DO Blaster are divided into pairs of pins. You can configure a jumper by enabling or disabling any of its pairs of pins. A pair of pins is enabled when a jumper block is placed over it as shown in Figure 1-6.

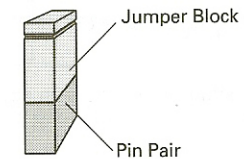

Figure 1-6: An enabled pair of pins.



A pair of pins is disabled when there is no jumper block placed on it or when a jumper block is placed over one pin as shown in Figure 1-7.

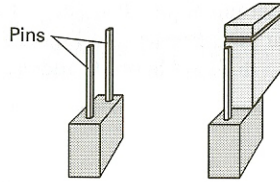

Figure 1-7: Two ways a pair of pins can be disabled.

## Identifying the Base I/O Address Jumper

The base I/O address jumper on your 3DO Blaster is shown in Figure 1-8.



Other jumpers on your 3DO Blaster are for factory use. You need not and should not change any of them.

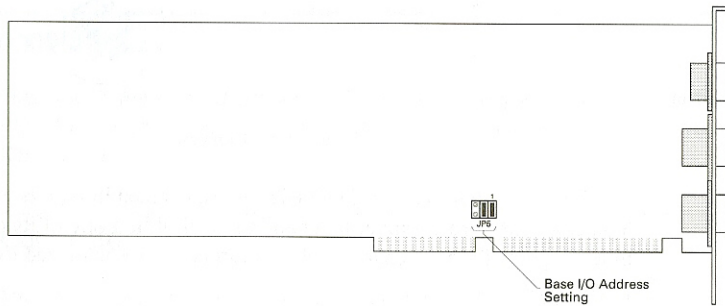

Figure 1-8: The base I/O address jumpers at default setting.



The  symbol indicates an enabled jumper.

## Knowing the Base I/O Address Jumper Setting

I/O addresses (or I/O address range) are areas of memory used by your computer's microprocessor to distinguish among various peripheral devices connected to your system when sending or receiving data. Your 3DO Blaster is such a peripheral device and occupies a changeable I/O address range. This range is represented by the base I/O or first address of that range. For your 3DO Blaster, the factory default base I/O address is 260H (260H means hexadecimal number 260) and is set by the configuration of jumper JP5 in the manner shown in Figure 1-9. You need to change this factory default setting of JP5 if another peripheral device in your system uses the same address. Instructions are provided in Chapter 5.

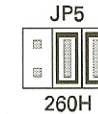

Figure 1-9: Base I/O address factory default setting 260H.

Other base I/O addresses set by JP5 are 270H, 280H, and 290H. Their corresponding I/O address ranges and the factory default's are:

Table 1-1: Available base I/O addresses and their ranges.

Base I/O Address	I/O Address Range
260H (Factory Default)	260H to 26FH
270H	270H to 27FH
280H	280H to 28FH
290H	290H to 29FH



Refer to Figure 5-3 to see the jumper settings for the above base I/O addresses.

---

## Setting Up Your Hardware

This chapter helps you install the 3DO Blaster hardware card into your computer and shows you how to make the necessary connections for it to function. If you are unfamiliar with 3DO Blasters, read Chapter 1, “Knowing Your 3DO Blaster,” first to familiarize yourself with it.

It is divided into the following sections:

- Installing Your 3DO Blaster
- Connecting Your 3DO Blaster to Creative CD-ROM Drive
- Connecting 3DO Control Pad to Your 3DO Blaster
- Connecting Your 3DO Blaster to Other Devices

---

### Installing Your 3DO Blaster



If your audio card and Creative CR-563 CD-ROM drive are not installed in your system, please install them, including their software, before you set up your 3DO Blaster. Refer to your audio card and CD-ROM drive documentation for installation instructions.

Before you install your 3DO Blaster, you need to verify that its base I/O address jumper, JP5, is configured correctly. Note that your 3DO Blaster has a factory default base I/O address of 260H. Check that the base I/O address jumper on your card is configured to this setting using Figure 2-1 below.

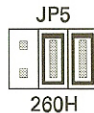

Figure 2-1: Factory default base I/O address setting 260H.

If your 3DO Blaster's base I/O address (or any address in its range) is used by another peripheral card, you need to change that setting of your 3DO Blaster. To do so, refer to Chapter 5, "Changing 3DO Blaster Hardware Setting".

To install your 3DO Blaster:

1. Touch your system's metal casing to ground yourself and discharge any static electricity in your body (see Figure 2-2).

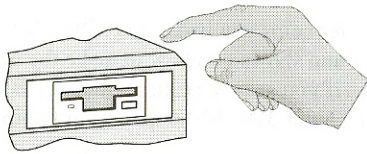

Figure 2-2: Discharge static electricity.

2. Switch off your system and all peripheral devices. Unplug the power cord from the wall outlet as depicted in Figure 2-3.

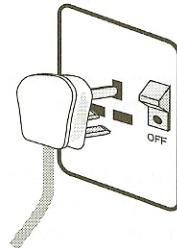

Figure 2-3: Remove power cord from wall outlet.



Your power cord and wall outlet may differ from those shown.

3. Remove the cover from your system (see Figure 2-4).

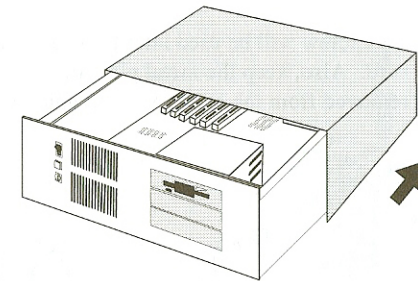

Figure 2-4: Remove system cover.

4. Locate a free 16-bit expansion slot (see Figure 2-5) next to your VGA card.

If no free slot is available, rearrange the peripheral cards so that your VGA card has a free slot next to it.

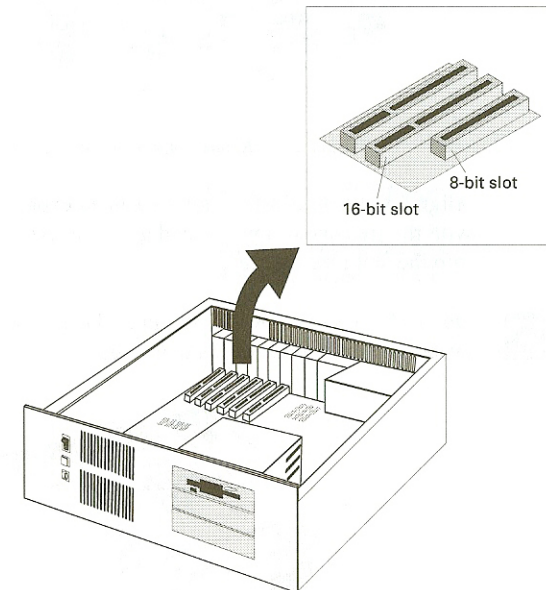

Figure 2-5: Locate free 16-bit slot.

5. Remove the metal plate from the expansion slot you have chosen as shown in Figure 2-6. Put the screw aside.



This screw will be used later to secure the mounting bracket of the card. Also, keep the metal plate in case your 3DO Blaster is removed from the expansion slot and you need to cover the slot.

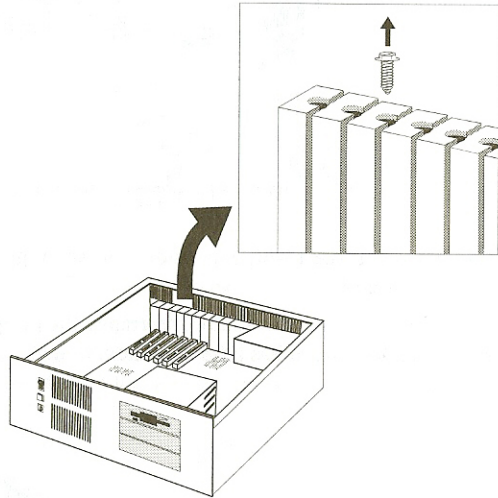

Figure 2-6: Remove metal plate from slot.

6. Align your 3DO Blaster's gold-stripped expansion bus connector with the free expansion slot and gently lower your 3DO Blaster into the slot (see Figure 2-7).



Do not force your 3DO Blaster into place. If it does not fit properly, gently remove it and try again.

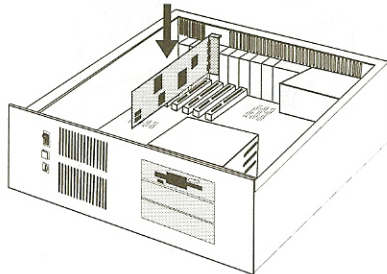

Figure 2-7: Inserting 3DO Blaster into slot.

7. Secure your 3DO Blaster to the expansion slot with the screw you removed from the metal plate as shown in Figure 2-8.

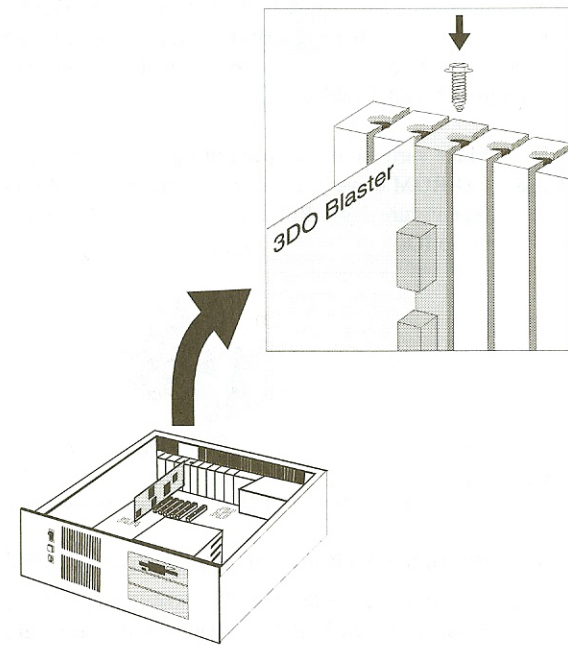



Figure 2-8: Securing 3DO Blaster.

Your 3DO Blaster is now installed. Go on to the next section to make the necessary connections for your 3DO Blaster to work.

## Connecting Your 3DO Blaster to Creative CD-ROM Drive

Two connections need to be made between your 3DO Blaster and your Creative CD-ROM drive so that the drive can send data and audio signals to your card. Specifically, you need to reconnect the existing CD-ROM Data and CD Audio cables to your 3DO Blaster.

 Make sure the ID jumper setting at the rear panel of the CD-ROM drive you are connecting your 3DO Blaster to is set to 0 (see Figure 2-9). Refer to your drive's documentation to change drive IDs.

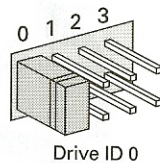



Figure 2-9: Your CD-ROM drive's ID jumper setting

To connect your 3DO Blaster to your Creative CD-ROM drive:

1. Disconnect the CD-ROM Data cable that is currently connected to your Creative CD-ROM drive from the peripheral card that it is connected to.

 Ensure that the other end of the cable remains connected to your drive.

2. Reconnect the CD-ROM Data cable to the CD-ROM Data connector on your 3DO Blaster as shown in Figure 2-10.

 Ensure that the colored wire on the cable is aligned with Pin 1 of the connector.

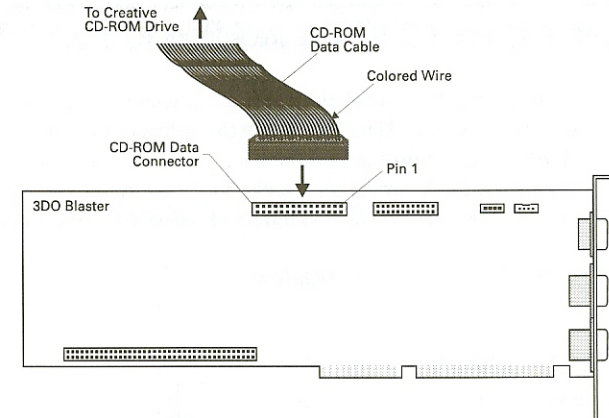



Figure 2-10: Reconnect CD-ROM Data cable from Creative CD-ROM drive to 3DO Blaster.

3. Disconnect the CD Audio cable that is currently connected to your Creative CD-ROM drive from the peripheral card that it is also connected to.

 Ensure that the other end of the cable remains connected to your drive.

4. Reconnect the CD Audio cable to the CD Audio-In connector on your 3DO Blaster as shown in Figure 2-11.

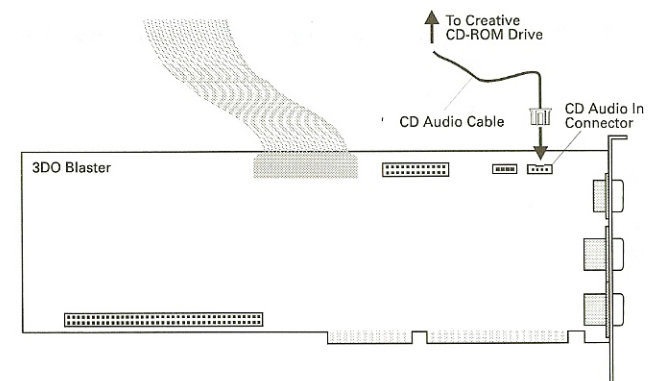

Figure 2-11: Reconnect CD Audio cable from Creative CD-ROM drive to CD Audio-In connector of 3DO Blaster.

## Connecting Your 3DO Control Pad to Your 3DO Blaster

To use the 3DO control pad supplied in your package, you need to connect it to your 3DO Blaster. Attach the control pad's cable to the 9 pin (DB9) 3DO Control port at the back panel of your 3DO Blaster (see Figure 2-12). Your 3DO control pad is now ready for use. Chapter 4, "Using 3DO Player" tells you how to use it to control your 3DO titles.

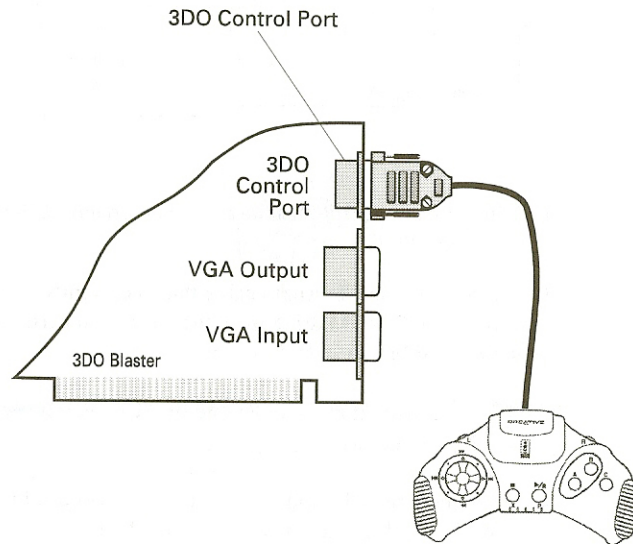

Figure 2-12: Connecting 3DO Control pad to your 3DO Blaster.

## Connecting Your 3DO Blaster to Other Devices

You need to connect your 3DO Blaster to your audio card, VGA card, and VGA monitor to hear sound and see images from your 3DO titles.

### Connecting Your 3DO Blaster to Audio Card

In order to hear sound, you need to connect your 3DO Blaster to the audio card in your computer.

To connect your 3DO Blaster to audio card (see Figure 2-13):

1. Connect a second CD Audio cable to the Audio-Out connector on your 3DO Blaster.
2. Connect the other end of the cable to the CD In connector on your audio card.

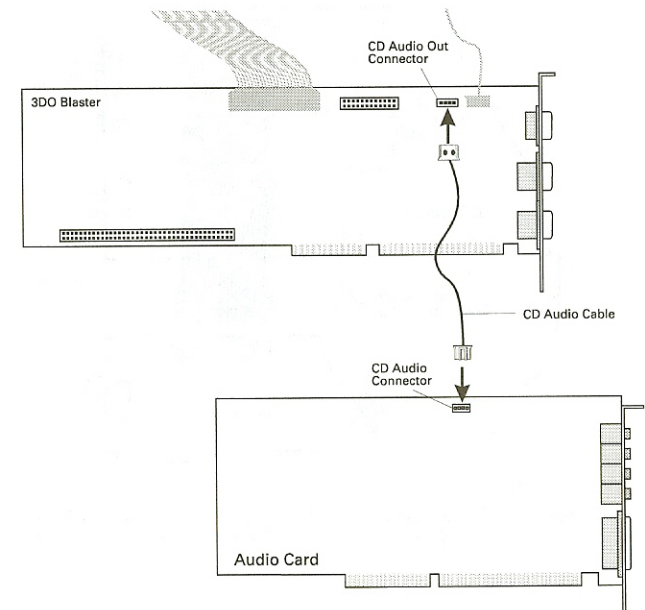



Figure 2-13: Connect CD Audio-Out connector on 3DO Blaster to CD In connector on audio card using CD Audio cable.

## Connecting Your 3DO Blaster to VGA Card

You must make two connections between your 3DO Blaster and VGA card. The first is between the VGA Feature connectors of both cards. The second is between the VGA Input connector of your 3DO Blaster and the VGA Output connector of your VGA card.

To connect the VGA Feature connectors of your 3DO Blaster and VGA card:

1. Attach the 26-pin female connector end of the VGA Feature Connector cable to the VGA Feature connector on your 3DO Blaster (see Figure 2-14).

 Ensure that the colored wire of the cable is aligned with Pin 1 of the connector.

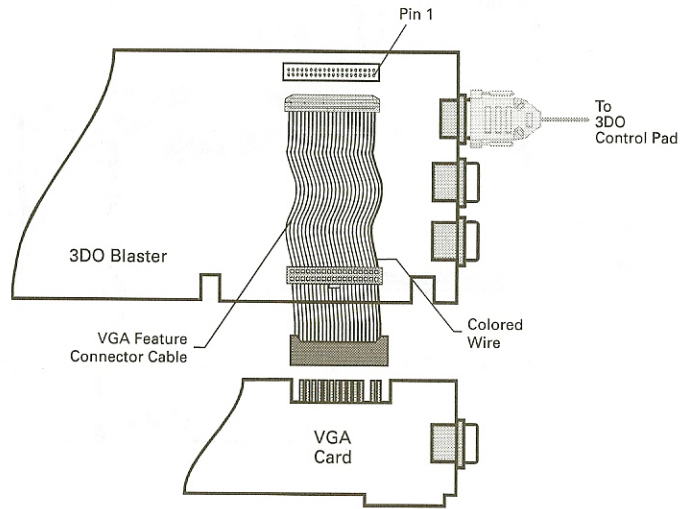

Figure 2-14: Connecting the VGA Feature connectors of 3DO Blaster and the VGA card using the VGA Feature Connector cable.

2. Attach the other end of the VGA Feature Connector cable to the VGA Feature connector of your VGA card as shown in Figure 2-14.



The VGA card in your system may have either a slot or 26-pin male VGA Feature connector. Use the corresponding connector on the free end of the VGA Feature Connector cable to connect to the VGA card.

To connect the VGA Input connector of your 3DO Blaster to the VGA Output connector of your VGA card (see Figure 2-15):

1. Attach one end of the VGA Loopback cable to the VGA Input connector of your 3DO Blaster.

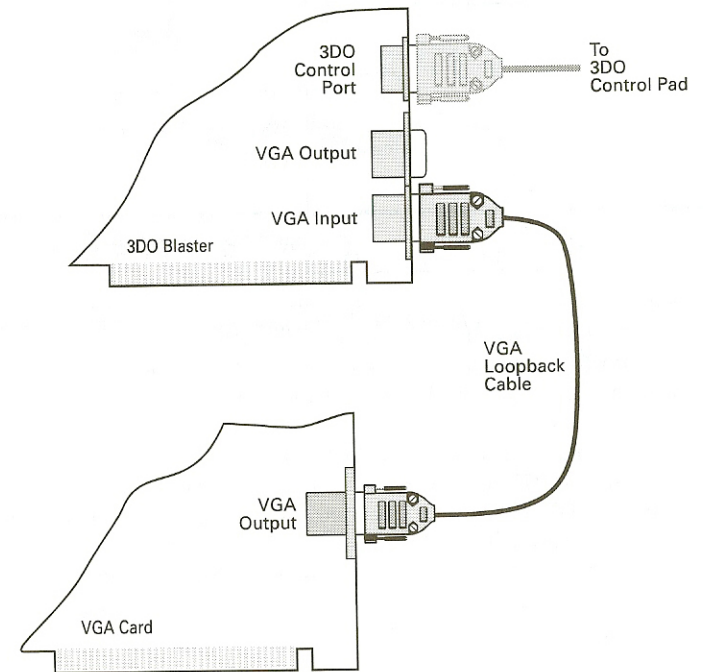

Figure 2-15: Connecting the 3DO Blaster to VGA card using the VGA Loopback cable.

2. Attach the other end of the VGA Loopback cable to the VGA Output connector of your VGA card.

## Connecting Your 3DO Blaster to VGA Monitor

To view images from your 3DO Blaster and the VGA card on your VGA monitor, connect the VGA monitor's cable to the VGA Output connector of your 3DO Blaster as shown in Figure 2-16.

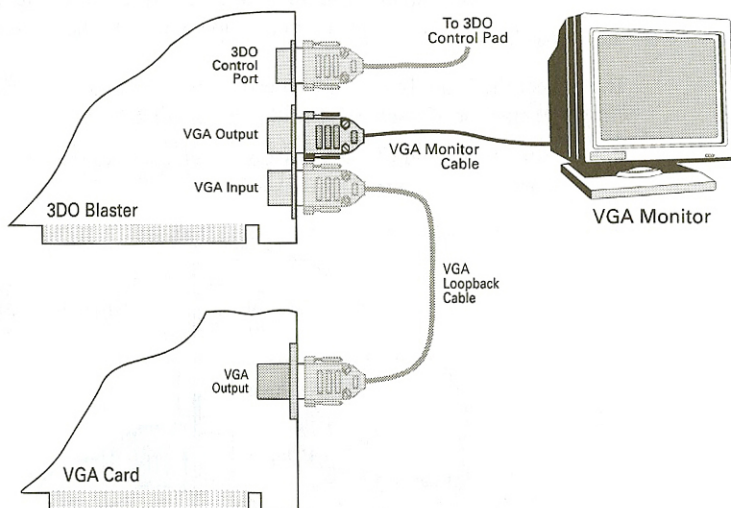

Figure 2-16: Connecting 3DO Blaster to VGA monitor.



---

## Setting Up Your Software

After installing and connecting your 3DO Blaster, you can begin setting up the software for your package. The software set up process involves setting up the software for your 3DO Blaster and running the 3DO Blaster Configuration utility.

This chapter is organized thus:

- Setting Up 3DO Blaster Software
- Using the 3DO Blaster Configuration Utility

---

### Setting Up 3DO Blaster Software



Before you proceed to set up the software for your 3DO Blaster, you must install the software for your audio card and Creative CD-ROM drive, if you have not already done so. Refer to your audio card's Getting Started and CD-ROM drive's documentation.

The first step in setting up your 3DO Blaster's software is running the SETUP.EXE program. This program is found in the 3DO Blaster installation diskette provided in your package. SETUP.EXE creates a directory in a drive of your choice to store all the necessary files needed for 3DO Blaster to work including those that are needed to run the 3DO Player application. As SETUP.EXE runs only in Windows, ensure you have Windows 3.1 installed before running it.

To run SETUP.EXE:

1. Insert the 3DO Blaster installation diskette provided into a disk drive.
2. If you are not in Windows, type WIN at the DOS prompt to start Windows.

3. In Program Manager, select Run from the File menu. The dialog box in Figure 3-1 appears.

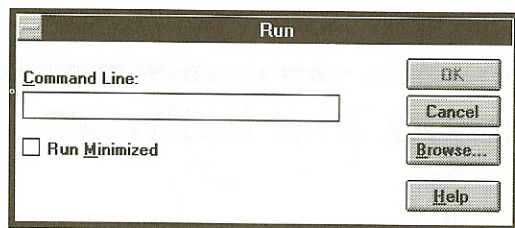

Figure 3-1: The Run dialog box.

3. In the Command Line text box, enter the path and name of your SETUP.EXE program. For example, if your installation diskette is in drive B, type B:\SETUP. The window in Figure 3-2 appears.

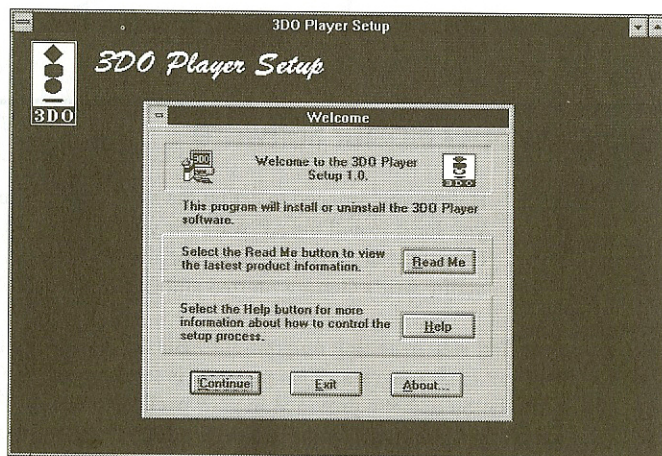

Figure 3-2: The 3DO Player Setup window.

4. In the Welcome dialog box, choose Read Me to obtain important information that you need to know about 3DO Blaster.
5. After you have finished reading the information, select Exit from the File menu.

6. In the Welcome dialog box, choose Continue. The Setup Options dialog box in Figure 3-3 appears.

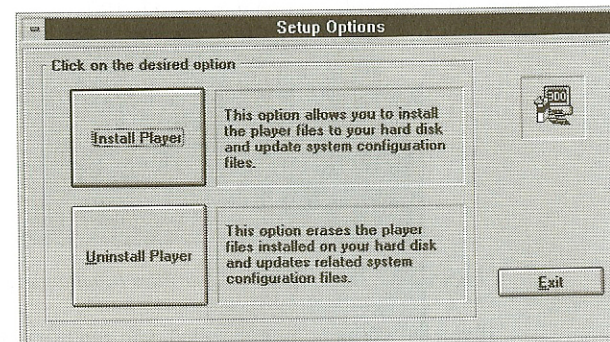

Figure 3-3: The Setup Options dialog box.

7. Choose Install Player. The Installation Path dialog box in Figure 3-4 appears.

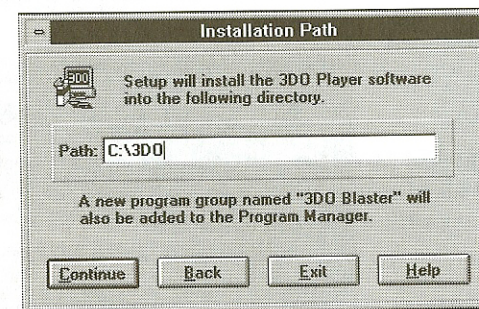

Figure 3-4: The Installation Path dialog box.

8. If you do not want to use the default path of C:\3DO to store the 3DO Blaster software, enter your desired path in the Path text box.

9. Choose Continue.

The VoiceAssist User Files Installation dialog box in Figure 3-5 appears.

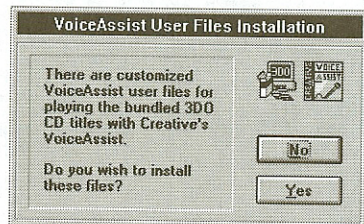

Figure 3-5: The VoiceAssist User Files Installation dialog box.

If you have VoiceAssist installed, you can install custom VoiceAssist user files of the 3DO Player and the bundled 3DO titles so that you can use voice to control them.

10. Choose Yes if you want to use VoiceAssist with your 3DO Player. Choose No if you do not want to use VoiceAssist or if you do not have it.

If you chose Yes, the VoiceAssist Installation Path dialog box in Figure 3-6 appears.

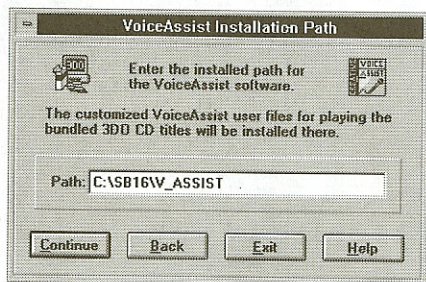

Figure 3-6: The VoiceAssist Installation Path dialog box.

Enter the path where your VoiceAssist software is stored and choose Continue.

SETUP.EXE creates the directory that you specified and copies all of the necessary 3DO files into that directory and the Windows directory. The custom VoiceAssist user files are copied into your VoiceAssist directory. Once that is completed, the 3DO Blaster program group is created. SETUP.EXE then starts the 3DO Blaster Configuration utility to create the environment statement needed for your 3DO Blaster to function. The following section tells you how to use this utility.

## Using the 3DO Blaster Configuration Utility

When the 3DO Blaster Configuration utility starts, the dialog box in Figure 3-7 appears.

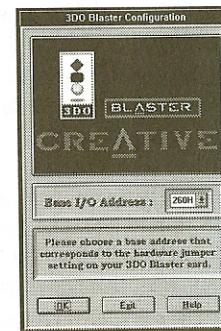

Figure 3-7: The 3DO Blaster Configuration dialog box.

You can use this dialog box to set the environment statement for your 3DO Blaster. To do so:

1. In the list box, select the base I/O address that corresponds to the one set by the jumper on your 3DO Blaster.
2. Choose OK.

The 3DO Blaster Configuration utility checks if the base I/O address you specified in the list box is the same as that specified by the base I/O address jumper on your 3DO Blaster. If they are different, you have to specify the correct address in the list box.

The 3DO Blaster Configuration utility also begins checking your computer for another peripheral device with the same base I/O address. If another peripheral device is found with the same base I/O address, you have to change the base I/O address jumper setting on your 3DO Blaster (refer to Chapter 5, “Changing 3DO Blaster Hardware Setting,” for instructions) and run the 3DO Blaster Configuration utility again (icon found in the 3DO Blaster program group).

The utility also checks your audio card for the port address of its CD-ROM interface (if one exists). If the port address is the same as the base I/O address you selected for your 3DO Blaster, a window appears notifying you of that. You need to refer to Chapter 5 to change the base I/O address jumper setting on your 3DO Blaster and run the 3DO Configuration utility again.

If no conflict is found, the 3DO Blaster Configuration utility modifies your computer's AUTOEXEC.BAT and CONFIG.SYS files as follows:

### CONFIG.SYS

- ❑ Update the /P parameter of your Creative CD-ROM drive's DEVICE statement (statement loading SBCD.SYS) with the base I/O address of your 3DO Blaster.
- ❑ Add /T:2 to your Creative CD-ROM drive's DEVICE statement (statement loading SBCD.SYS). /T:2 specifies that your CD-ROM drive is connected to your 3DO Blaster.



After the above two modifications, the statement loading SBCD.SYS should look like:

DEVICE=*path*\SBCD.SYS /D:MSCD001 /P:260 /T:2  
where *path* is the drive and directory your SBCD.SYS is stored.  
Note that other parameters may be present.

- ❑ Add the following statement to the line just before your Creative CD-ROM drive's DEVICE statement:

**DEVICE=C:\3DO\CD3DOBLT.SYS /P:260**

where

- C:\3DO** Specifies the drive and directory location of your 3DO Blaster software, the factory default being C:\3DO. This phrase is different if you specified a different location to install your 3DO Blaster software.
- /P:260** Specifies the base I/O address of your 3DO Blaster, the factory default being 260H. This phrase is different if you installed your 3DO Blaster at a different base I/O address.

### AUTOEXEC.BAT

- ❑ Add the following statement:

SET 3DOBLST=C:\3DO A:260

where

**C:\3DO** Specifies the drive and directory location of your 3DO Blaster software, the factory default being C:\3DO. This phrase is different if you specified a different location to install your 3DO Blaster software.

**A:260** Specifies the base I/O address of your 3DO Blaster, the factory default being 260H. This phrase is different if you installed your 3DO Blaster at a different base I/O address.

The statement added to your CONFIG.SYS file loads the CD3DOBLT.SYS device driver that enables your Creative CD-ROM drive to switch from 3DO mode to normal CD-ROM mode. This device driver must always be loaded before your Creative CD-ROM drive's SBCD.SYS driver. Hence, if you edit your CONFIG.SYS file with a text editor, ensure that the DEVICE statement loading CD3DOBLT.SYS is always one line before the DEVICE statement loading SBCD.SYS.

Once the AUTOEXEC.BAT and CONFIG.SYS files are modified, the 3DO Blaster Configuration utility reboots your computer. The environment statement contains environment settings for your 3DO Blaster and is executed every time your computer starts up. This is done so that your computer can recognize the presence of 3DO Blaster.

Your 3DO Blaster's software is now installed. You can reverse the installation process resulting in removal of all 3DO software and the installation directory created by SETUP.EXE. To do that, choose Uninstall Player in the Setup Options dialog box shown in Figure 3-3.

---

## Using 3DO Player

3DO Player is the application that allows you to play your 3DO titles in the Windows environment on your PC. This chapter describes 3DO Player and gives you instructions to use its features.

It is organized into the following sections:

- Starting 3DO Player
- Knowing the 3DO Player Window
- Starting a 3DO Title
- Controlling a 3DO Title
- Customizing 3DO Player
- Saving a Title
- Quitting 3DO Player

---

## Starting 3DO Player

To start 3DO Player:

1. Double-click the 3DO Player icon in the 3DO Blaster group window.

The window similar to the one in Figure 4-1 appears.

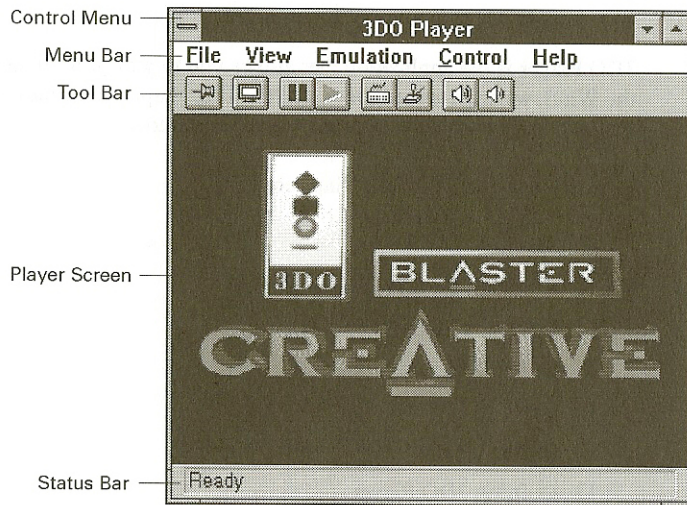

Figure 4-1: The 3DO Player window.



If the Creative 3DO Blaster title screen seen in Figure 4-1 does not appear or is distorted, refer to Appendix A to find out how to use the 3DO Video Overlay Setup to obtain a proper display.

---

## Knowing the 3DO Player Window

The 3DO Player window has five main features. They are:

- Control Menu
- Player Screen
- Status Bar
- Menu Bar
- Tool Bar

---

## Control Menu

This menu contains standard Windows commands for manipulating and closing the 3DO Player window.

---

## Player Screen

The player screen displays images from your 3DO titles as well as the memory resident introduction clip. The player screen can be resized by dragging the border of the 3DO Player window. You can also enlarge it to occupy your entire monitor screen by clicking the Full Screen button in the tool bar.

---

## Status Bar

The status bar provides information about the function of any of the tool bar buttons or menu commands that your pointer is currently on top of.

---

## Menu Bar

The menu bar contains the File, View, Emulation, Control, and Help menus. These menus contain commands that allow you to work with your 3DO title, 3DO Control Pad, and online help. They are described in the following sections.

---

## File Menu



Figure 4-2: The File menu.

Reset	Restarts the 3DO title that is in your Creative CD-ROM drive.
Exit	Quit 3DO Player.

---

## View Menu

<b>View</b>	
Full Screen	Ctrl+F
Always on Top	Ctrl+T
✓ Toolbar	Ctrl+B
✓ Status Bar	Ctrl+U
Freeze	Ctrl+A
Unfreeze	Ctrl+Z

Figure 4-3: The View menu.

Full Screen	Enlarge the player screen to occupy your entire monitor screen. All other visible components in the 3DO Player window are hidden.
Always On Top	Display the 3DO Player window above other applications.
Toolbar	Enable or disable the tool bar.
Status Bar	Enable or disable the status bar.
Freeze	Freeze the image in the player screen.
Unfreeze	Unfreeze the image in the player screen.

---

## Emulation Menu

<b>Emulation</b>	
Keyboard	Ctrl+K
Joy Stick	Ctrl+J
Keyboard Mapping...	Ctrl+E
Joy Stick Calibration...	Ctrl+L

Figure 4-4: The Emulation menu.

Keyboard	Enable or disable keyboard emulation of 3DO control pad.
Joystick	Enable or disable joystick emulation of 3DO control pad.
Keyboard Mapping	Open a dialog box to re-map 3DO control pad buttons to keys on your keyboard.
Joystick Calibration	Enable the Control Panel joystick calibration utility to calibrate your joystick for 3DO

---

## Control Menu

<b>Control</b>	
Volume...	Ctrl+V
Color Key...	Ctrl+C
Video Overlay..	Ctrl+O

Figure 4-5: The Control menu.

Volume	Display the Volume dialog box to adjust the volume of your 3DO title.
Color Key	Display the color key dialog box to change the color key.
Video Overlay	Display the Video Overlay dialog box to change the overlay display mode of your 3DO Blaster.

---

## Help Menu

<b>Help</b>	
Contents	F1
About...	

Figure 4-6: The Help menu.

Contents	Open a window showing the table of contents for topics concerning your 3DO Player.
About...	Open a dialog box showing copyright information and development credits for 3DO Player.

## Tool Bar

The tool bar shown in Figure 4-7 contains buttons for frequently used menu commands. It can be toggled on or off using the Toolbar command in the View menu.

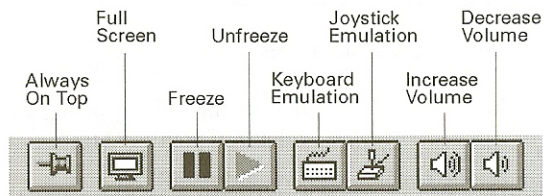

Figure 4-7: The 3DO Player tool bar.

The function of each button in the tool bar is as follows:

Always On Top	Perform the same function as the Always On Top command in the View menu.
Full Screen	Perform the same function as the Full Screen command in the View menu.
Freeze	Perform the same function as the Freeze command in the View menu.
Unfreeze	Perform the same function as the Unfreeze command in the View menu.
Keyboard Emulation	Perform the same function as the Keyboard command in the Emulation menu.
Joystick Emulation	Perform the same function as the Joystick command in the Emulation menu.
Increase Volume	Increase the volume of audio output from your 3DO title through your audio card.
Decrease Volume	Decrease the volume of audio output from your 3DO title through your audio card.

## Starting a 3DO Title

To start playing a 3DO title:

1. Insert a 3DO CD into your Creative CD-ROM drive.
2. Double-click the 3DO Player icon in the 3DO Blaster group.

The 3DO Player window in Figure 4-1 appears displaying the 3DO Blaster introduction. At the same time, your Creative CD-ROM drive begins reading the 3DO title and displays it in a few seconds.



If misalignment occurs between your 3DO title's images and the 3DO Player window or no image is displayed in the player screen, quit 3DO Player and start the 3DO Video Overlay Setup utility by double-clicking its icon in the 3DO Blaster program group. This utility helps you to fine tune alignment between the 3DO images and your 3DO Player window. Refer to Appendix A to find out how to use the utility. When you have finished using the utility, quit it then start 3DO Player. 3DO Player will not work properly if the setup utility is running at the same time.

## Controlling a 3DO Title

The 3DO title you started can be controlled using one of the following:

- Your 3DO Control Pad
- Your Keyboard
- Your Joystick
- Your Voice



## Using Your 3DO Control Pad

Your 3DO control pad is designed solely for controlling 3DO titles. Its buttons are laid out within your fingers' reach so that you can register your reactions faster when you are playing a 3DO title. It can be used once a 3DO title starts (provided the Keyboard or Joystick commands in the Emulation menu are unchecked). Figure 4-8 shows the features of your 3DO control pad.

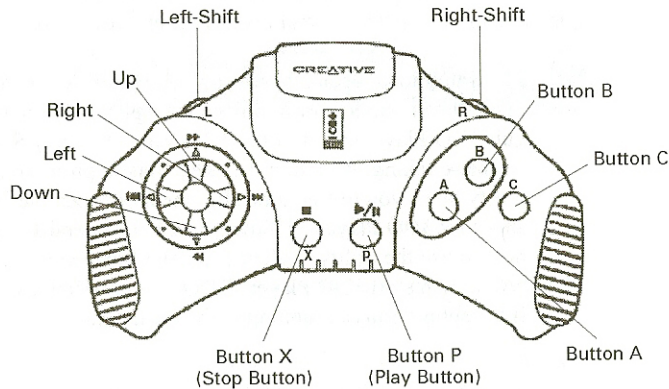

Figure 4-8: The 3DO control pad.

Generally, you can use the X button to stop a 3DO title and the P button to pause or play it. The circular button pad on the left gives you directional control of an object in a 3DO title while the A, B, and C buttons on the right allows you to activate a certain feature in a 3DO title. The specific function of each button varies from title to title. Read the documentation that accompanies each title for more information.

## Using Your Keyboard

3DO Player allows you to substitute the 3DO control pad with your keyboard. When you do that, all the functions performed by the 3DO control pad can be performed by the keyboard. Hence, you can use your keyboard to control or play 3DO titles. Before enabling the substitution, you need to define or map the control pad buttons to keys on your keyboard.

To map control pad buttons to keyboard keys:

1. Select the Keyboard Mapping command in the Emulation menu. The Keyboard Emulation Configuration dialog box in Figure 4-9 appears.

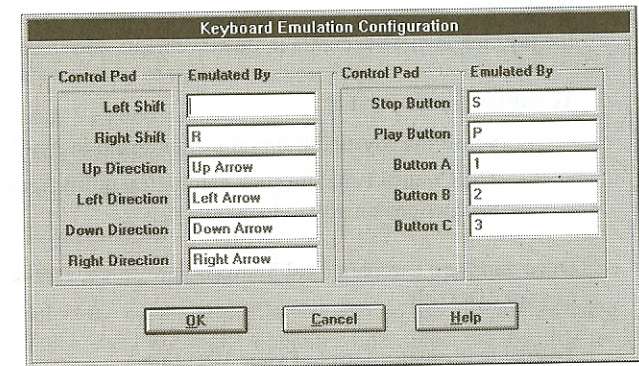

Figure 4-9: The Keyboard Emulation Configuration dialog box.

2. Click on the text box of the button that you want to define.
3. Press the key that you want to remap the button to.

The key's name appears in the text box.



Since the function of each control pad button differs among titles, you may wish to change the mapped keys when you start each new title. Choose each key logically bearing in mind its function in the title and the speed and frequency that you need to press it.

4. Perform steps 2 and 3 again for each mapped key that you wish to change.
5. When you are done, choose OK.

To enable keyboard control of your 3DO title:

1. Select the Keyboard Emulation command in the Emulation menu.

The function of each button on the control pad is now performed by the keys you defined in the Keyboard Emulation Configuration dialog box. To use your control pad again, select the Keyboard Emulation command again.

---

## Using Your Joystick

You can also use your joystick (if you have one connected to your computer) to perform the functions of the control pad. Your joystick can then take the place of the control pad in controlling your 3DO title.

Before you use the joystick, you should calibrate it. When it is calibrated, the joystick is more accurate in its movements on screen.

To calibrate your joystick:

1. Select the Joystick Calibration command in the Emulation menu.

The Control Panel joystick calibration utility appears. Follow the instructions on screen to continue.

Once you have completed calibrating the joystick, enable joystick control of your 3DO title.

To enable joystick control of your 3DO title:

1. Select the Joystick Emulation command in the Emulation menu.

When you emulate the 3DO control pad with a joystick, several of the 3DO control pad buttons are remapped to your keyboard. This is because there are not enough buttons on your joystick. The buttons on your joystick are remapped with the A, B, and C buttons of the control pad. The Right-Shift, Left-Shift, Stop, and Play buttons on your control pad do not have buttons on the joystick to map to. If these buttons are needed by your 3DO title, 3DO Player remaps them to your keyboard. Hence, whenever you activate joystick emulation of your control pad, keyboard emulation is also activated.

---

## Using Your Voice

You can use your voice to control 3DO titles and your 3DO Player. To do so, you need to have VoiceAssist installed in your system (before you install your 3DO Blaster software). With VoiceAssist, you can use your voice to activate all commands in a 3DO title and your 3DO Player. Several custom user files with all the commands in 3DO Player and the bundled 3DO titles were copied into your VoiceAssist directory if you chose to install them during the software installation of your 3DO Blaster. You need to train the commands in these files in order to use them. But first, you need to select and make your own personal copy of the custom user files.



You must create your own personal copy of each title's custom file. This is done to retain the original custom file for future use.

To make your copy of the custom user files:

1. Start VoiceAssist.
2. Click the Menu button.  
A drop-down menu appears.
3. Select the User command.  
The User & Application Files dialog box appears.
4. Select the custom user file you want to use. If you are using VoiceAssist to control a bundled title, select the user file for that title. Otherwise, select the generic 3DO Player user file called 3DOPLAY.
5. Choose Copy.
6. Enter your desired name of your new user file.
7. Choose OK.  
Your new file's name appears in the list of user files.
8. Verify that your new user file is selected and choose Close.

A personal copy of the custom user file you want to use is now made. If you want to use another custom user file, ensure you make a copy of that file and use the copy.

You can now begin training the commands in your personal user file.

To train commands:

1. Start 3DO Player so that your user file can be enabled.
2. Click VoiceAssist's Menu button.  
A drop-down menu appears.
3. Select the Training command.  
A training dialog box showing all the commands in your user file appears.



If you selected a bundled title's custom file, you can see commands specific to that title below the commands for the 3DO Player. If you selected the generic 3DOPLAY user file, commands to control the control pad are listed below the commands for the 3DO Player. You can train these control pad commands to control your specific title by speaking the title's commands for the respective control pad buttons that activate them.

4. Choose All to train all the commands or Single to train only the commands you want to use.  
The Voice Training dialog box appears.
5. Select the number of trainings you want and choose OK.
6. Speak the command into your microphone.  
When you are finished, begin training for the next command.
7. When you have finished training all commands, choose Save.

The trainings for the commands in your user file are now saved.

You can begin using VoiceAssist to control your 3DO Player and title. Refer to your VoiceAssist User's Guide for more information on using VoiceAssist.

---

## Customizing 3DO Player

You can customize your 3DO Player by doing the following:

- Resize the 3DO Player Window
- Change Screen Modes
- Change Color Key
- Change Overlay Display Mode
- Adjust Volume

---

### Resizing the 3DO Player Window

Like other Windows applications, you can resize the 3DO Player window to suit your viewing preference.

To resize the window:

1. Click and drag any corner or side of the window to your desired size.
2. Release the mouse button.

Your 3DO Player window changes to the new size. Notice that the player screen also changes, altering the aspect ratio (ratio of width to height) of the image in it.



You can put the 3DO Player window on top of other application windows even when another application is active. To do so, select the Always on Top command in the View menu. With this feature enabled, you can watch your 3DO titles' images when you are using another application.

## Changing Screen Modes

When 3DO Player first starts, it is always a window. You can change the 3DO Player to full screen mode so that images from your 3DO title occupy the entire screen.

To change the screen mode:

1. Select the Full Screen command in the View menu.

The image displayed enlarges to full screen and the menu and status bars are disabled. When you are in full screen mode, the following hot keys will be useful:

<Ctrl><R>	Reset 3DO Player.
<Ctrl><A>	Freeze image.
<Ctrl><Z>	Unfreeze image.
<Alt><+>	Increase volume.
<Alt><->	Decrease volume.
<Ctrl><C>	Change color key.
<Ctrl><O>	Change overlay display mode.
<Ctrl><K>	Enable keyboard emulation.
<Ctrl><E>	Map keyboard.
<Ctrl><J>	Enable joystick emulation.
<Ctrl><L>	Calibrate joystick.
<F1>	Enable online help.
<Alt><F4>	Quit 3DO Player.

To revert to windowed mode again, click the left or primary button of your mouse or press <Ctrl><F>.

## Changing Color Key

Images from your 3DO title are displayed through a specific VGA color. This color is called the color key. Wherever this color appears on your monitor screen, images from your 3DO title are displayed through it. Hence, instead of seeing that color, you will see images from your 3DO title.

The factory default color key is magenta. If your monitor screen has a large amount of magenta visible resulting in 3DO images appearing outside of the player screen, you need to change the color key to a VGA color that doesn't appear or is not anticipated to appear on your monitor screen.

To change the color key:

1. Select the Color Key command in the Control menu.

The Color Key dialog box in Figure 4-10 appears. The currently selected color key is the square with images showing through it.

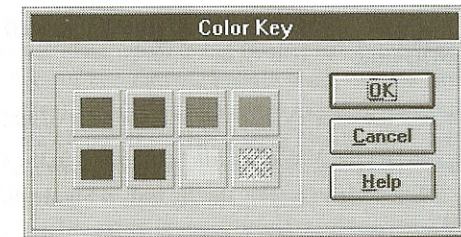

Figure 4-10: The Color Key dialog box.

2. Select the color that is not visible on your monitor screen or one that occurs the least.
3. Choose OK.

Images from your 3DO title now appear only in the player screen. If 3DO images still appear sporadically on your monitor screen, select another color key for your 3DO Player.

## Changing Overlay Display Mode

Your 3DO Blaster's graphics engine uses a technique called interlacing to display the images from your 3DO title. Interlacing displays images by dividing your screen into alternating odd and even horizontal lines. The way these lines are used to display the images depends on the overlay display mode being used. The four modes available are: Computer Mode Field 1, Computer Mode Field 2, Anti-flicker TV Mode, and Anti-tearing TV Mode. Their usage of the odd and even lines are as follows:

- Computer Mode Field 1 uses only the odd lines to display images.
- Computer Mode Field 2 uses only the even lines to display images.
- Anti-flicker TV Mode uses both odd and even lines to display images. The odd and even lines are used alternately to display an image.
- Anti-tearing TV Mode uses both odd and even lines to display images. All the odd lines are used first to display the images, then the even lines.

By using different modes, you can change the look of the images from your 3DO title.

To change the overlay display mode of your 3DO Blaster:

1. Select the Video Overlay command in the Controls menu.  
The Video Overlay dialog box in Figure 4-11 appears.

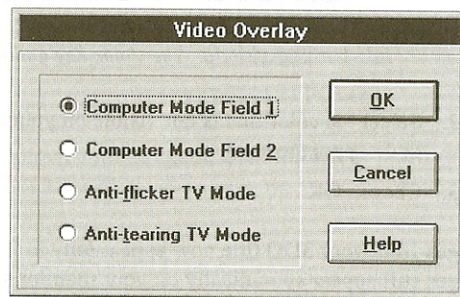



Figure 4-11: The Video Overlay dialog box.



The default mode is Computer Mode Field 1 which uses only the odd lines.

2. Select an overlay display mode using the following instructions:
  - If you want to use either the odd or the even lines to display your 3DO title's images, select Computer Mode Field 1 or Computer Mode Field 2 respectively. If the overlay display is in Computer Mode Field 1 and your 3DO title's images appear clear and sharp, we recommend that you do not change to another mode.  
  
 Most 3DO titles use Computer Mode Field 1 to display images (only the odd lines are used). This results in sharp images when you select that mode. Some titles use Computer Mode Field 2 to display images. For these titles, Computer Mode Field 2 gives a sharper look while Computer Mode Field 1 gives a softer look. The effect each mode gives depends on which mode your title's developer uses. Most developers use Computer Mode Field 1.
  - If you want to use both odd and even lines to display your 3DO title's images, select either Anti-flicker or Anti-tearing TV Mode. Images displayed in Anti-flicker TV Mode do not flicker. But fast-moving images exhibit the "tearing effect" (edges of fast-moving images seem to "tear" away from other images). Fast-moving images displayed in Anti-tearing TV Mode do not have the "tearing effect". But some images flicker when viewed closely in that mode. If your title does not have fast-moving images, select Anti-flicker TV Mode. If it has fast-moving images, select Anti-tearing TV Mode.
3. Choose OK once you have selected your overlay display mode.

## Adjusting Volume

You can adjust the volume of the 3DO Player.

To adjust volume:

1. Select the Volume command in the Control menu.  
The Volume control in Figure 4-12 appears.

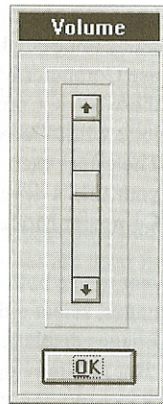

Figure 4-12: The Volume control.

2. Move the slider thumb upwards to increase the volume or downwards to decrease the volume of your 3DO Player.
3. Choose OK.

You can also click the Increase Volume or Decrease Volume buttons in the tool bar to adjust the volume of your 3DO Player.

## Saving a Title

Certain 3DO titles offer a save feature that enables you to store a title in your 3DO Blaster memory (in the 32 KB of battery-backed SRAM). When this save feature is used, you can quit the title and start it again later at the point where you saved it. For example, if you are at level 4 in a game title, you can save the title at this point and quit the title. When you start that title again, you can continue playing it from level 4, the point where you saved it. Consult your respective 3DO title's documentation on how to save and start the title. Different 3DO titles have different characteristics of saving and starting.

As you save more titles into the SRAM on your 3DO Blaster, you need to be aware of the amount of free memory left in the on-board SRAM. You can refer to the capacity indicator at the top of the Storage Manager screen to see the percentage of free and occupied memory.

To view the Storage Manager screen:

1. Remove any CDs from your Creative CD-ROM drive's disc tray and close the tray.
2. Wait a few seconds for the 3DO Blaster introduction screen shown in Figure 4-13 to appear.

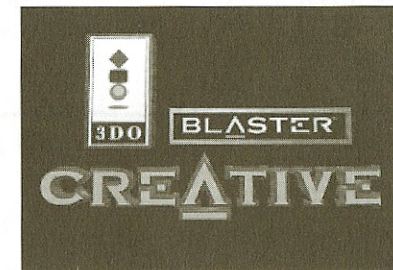

Figure 4-13: The 3DO Blaster introduction screen.

3. Press button X on your control pad or the X button equivalent on your keyboard.

The Storage Manager screen appears.

If the capacity at the top of the screen shows a small amount of free memory or no free memory (all 32 KB of SRAM is occupied), you need to delete one or more saved titles in order to vacate SRAM space to store new titles.

To delete a saved title:

1. From the displayed list of saved titles, select the one that you want to delete and press button A on your control pad.  
A prompt to confirm the deletion appears.
2. Press button A to confirm.

The selected title is now deleted from the list. The amount of memory space occupied by each saved title depends on how much information needs to be saved by that title. See the Storage Manager's title list to see the amount of space occupied by each title.

When you have finished viewing the Storage Manager screen, press button X to exit. Load the title that you want to play into your Creative CD-ROM drive.

---

## Quitting 3DO Player

To quit 3DO Player:

1. Select the Exit command in the File menu.

# 5

---

## Changing 3DO Blaster Hardware Setting

This chapter shows you how to change the configuration of the jumpers on your 3DO Blaster. It provides you with instructions on how to remove and place the plastic jumper blocks that help define jumper configurations.

The appendix is sectioned into the following:

- Changing Jumper Configuration
- Changing Base I/O Address Jumper



Do not change the default base I/O address of your 3DO Blaster unless absolutely necessary, such as in the case when there is a hardware conflict with another peripheral device. If you do change it, remember to run the 3DO Configuration utility to update the statements in your AUTOEXEC.BAT and CONFIG.SYS files.

---

## Changing Jumper Configuration

Each jumper on your 3DO Blaster can be configured to different settings by changing the locations of the jumper blocks on it. Before changing the configuration of a jumper, you should identify the current and the proposed new settings. You can then proceed to change the location of the jumper blocks.

To change the location of jumper blocks:

1. Touch your system's metal casing to discharge any static electricity from your body.
2. Switch off your computer and all other peripheral devices.
3. Remove the system's cover and your 3DO Blaster from the system.
4. Using Figure 5-3, identify the pair(s) of jumpers to place block(s) on for your desired base I/O address setting.



- Remove the jumper block(s) from the pair(s) of pins that do not need the block(s) as shown in Figure 5-1.

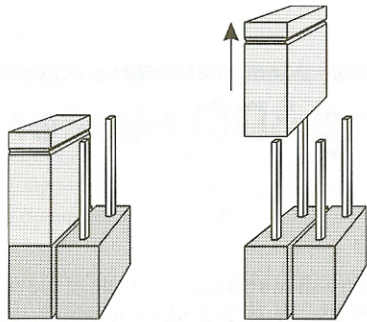

Figure 5-1: Removing jumper block.

- Place the jumper block(s) as shown in Figure 5-2.

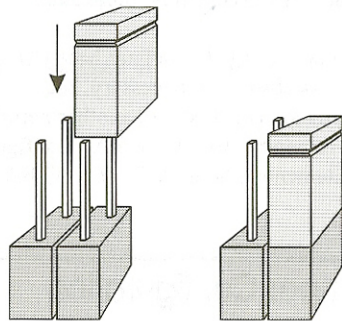

Figure 5-2: Inserting a jumper block.

- Install your 3DO Blaster in your computer. Refer to Chapter 2 for installation instructions.
- Switch your computer on.

## Changing Base I/O Address Jumper

The factory default base I/O address is 260H. This is represented on your 3DO Blaster by a unique configuration of jumper blocks on jumper JP5. By rearranging the jumper blocks on JP5, you can obtain other base I/O addresses for your 3DO Blaster. Other base I/O addresses available are 270H, 280H, and 290H. Their corresponding locations of jumper blocks and the factory default's are shown in Figure 5-3.



When you select a base I/O address, ensure that no other peripheral device is using that address. Otherwise, a hardware conflict will occur between your 3DO Blaster and that device.

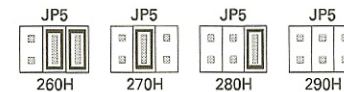

Figure 5-3: The configuration of jumper JP5 for available base I/O addresses.

If a hardware conflict occurs again, select another base I/O address for your 3DO Blaster.



If your audio card has a CD-ROM interface installed and your audio card's base I/O address is set at 260H or 280H, please observe the following:

- If your audio card's base I/O address is set at 260H, do not set your 3DO Blaster's base I/O address to 260H or 270H.
- If your audio card's base I/O address is set at 280H, do not set your 3DO Blaster's base I/O address to 280H or 290H.

---

# Appendices

# A

## Using 3DO Video Overlay Setup

The software in your package includes the 3DO Video Overlay Setup utility. If your 3DO title's images do not appear when you run your 3DO Player or if the images are misaligned with the player screen, use 3DO Video Overlay Setup to adjust the video overlay settings of your 3DO Blaster so that it can synchronize with your VGA card.

To start 3DO Video Overlay Setup:

1. In the 3DO Blaster program group, double-click the 3DO Video Overlay Setup icon.

The 3DO Blaster Video Overlay Setup dialog box in Figure A-1 appears.

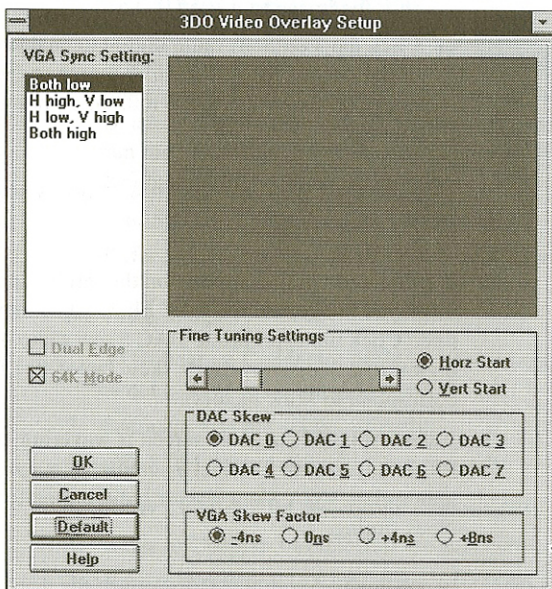

Figure A-1: The 3DO Blaster Video Overlay Setup dialog box.

Load your CD-ROM drive with a 3DO compatible CD. Wait a few seconds for the drive to read the data in the CD. 3DO images should appear in the 3DO Blaster Video Overlay Setup dialog box.

If no images appear, click on each option in the VGA Sync Setting list box until you see an image. Each option represents a synchronization setting of which one will correspond to your VGA card. If your display is in Hi-Color mode, the Dual Edge check box will be usable. Enable it to see if the images have a better appearance. The 64K Mode check box is also enabled by default if your display is in Hi-Color mode. If you want to use 32K Hi-Color mode, disable this check box.

Once images appear, you need to fine-tune their alignment with your VGA card. The misalignment is caused by the video and VGA clocks when they are not synchronized. Use the controls in the Fine Tuning Settings group box to synchronize the clocks.

To align displayed images with your VGA card:

- Use the slide bar as follows:
  - Click the Horz Start radio button to enable horizontal alignment of the displayed image. Move the slider thumb to the left to shift the image to the right or move it to the right to shift the image to the left.
  - Click the Vert Start radio button to enable vertical alignment of the image. Move the slider thumb to the left to shift the image downward or move it to the right to shift the image upward.



Adjust the slider thumb so that it is positioned at the center of the display area.

- If a thin vertical line appears on the left or right side of the displayed image, use the DAC Skew adjustment to get rid of the line. Click the appropriate DAC Skew radio button to change the digital-to-analog converter's skew factor (the DAC numbers correspond to skew factors).
- If the displayed image on screen is wavering, use the VGA Skew Factor adjustment to select a stabilized image. Click the appropriate VGA Skew Factor radio button to change the VGA clock timing.

Once you are satisfied with the alignment of the displayed image, choose OK to quit 3DO Video Overlay Setup. Your adjustments will be evident when you next start 3DO Player.

## Troubleshooting Guide

This appendix provides you with causes and solutions for some common problems you might face. You can also double-click the 3DO PLAYER README icon in the 3DO Blaster group for more troubleshooting information.

- |                  |                                                                                                                                                                                                                                                                                                                                                                                                                                                                                                                                                                                                            |
|------------------|------------------------------------------------------------------------------------------------------------------------------------------------------------------------------------------------------------------------------------------------------------------------------------------------------------------------------------------------------------------------------------------------------------------------------------------------------------------------------------------------------------------------------------------------------------------------------------------------------------|
| <b>Problem</b>   | Error in opening MCI Driver or 3DO Player.                                                                                                                                                                                                                                                                                                                                                                                                                                                                                                                                                                 |
| <b>Causes</b>    | <ol style="list-style-type: none"> <li>3DOBLST environment string was not set up properly.</li> <li>The applications were not set up properly.</li> <li>3DO Blaster was not installed correctly.</li> </ol>                                                                                                                                                                                                                                                                                                                                                                                                |
| <b>Solutions</b> | <ol style="list-style-type: none"> <li>Check that the AUTOEXEC.BAT file contains a statement similar to:<br/>           SET 3DOBLST=C:\3DO A:260<br/>           Make sure that the path of your 3DO Blaster software is specified correctly if it is not C:\3DO. Also, ensure that the parameter settings reflect those of your 3DO Blaster. If any of the entries are missing, you need to run the 3DO Blaster Configuration utility(double-click that icon in the 3DO Blaster group).</li> <li>Run SETUP.EXE again (see Chapter 3).</li> <li>Refer to Chapter 2 to install 3DO Blaster again.</li> </ol> |
| <b>Problem</b>   | No video image.                                                                                                                                                                                                                                                                                                                                                                                                                                                                                                                                                                                            |
| <b>Causes</b>    | <ol style="list-style-type: none"> <li>VGA Feature Connector cable or VGA Loopback cable is not connected to the video card.</li> <li>Software was not set up properly.</li> <li>CD-ROM drive not functioning properly.</li> </ol>                                                                                                                                                                                                                                                                                                                                                                         |
| <b>Solutions</b> | <ol style="list-style-type: none"> <li>Refer Chapter 2 for the correct connections.</li> <li>Refer to Chapter 3 to reinstall the software.</li> <li>Ensure that your CD-ROM drive's ID is set to 0. If problem persists, refer to your CD-ROM drive's manual for more troubleshooting tips.</li> </ol>                                                                                                                                                                                                                                                                                                     |



**Problem** Displayed image has magenta or black border.  
**Cause** Image is not aligned with the VGA monitor.  
**Solution** Run the Video Overlay Setup utility in Appendix A.

**Problem** Flickering of VGA screen.  
**Cause**

1. Some connections are not secure.
2. Screen resolution is not supported.
3. Video overlay is in the wrong mode.

**Solution**

1. Ensure that the VGA Feature Connector and VGA Loopback cables are secure.
2. Ensure that the maximum resolution of your VGA color mode is set to 800 x 600. (For best performance, we recommend using 640 x 480 resolution.)
3. Run 3DO Blaster Video Overlay Setup to adjust the display before running 3DO Player.

**Problem** Flickering of displayed image.  
**Cause**

1. Some connections are not secure.
2. CD-ROM drive may not be functioning.

**Solution**

1. Ensure that the VGA Feature Connector and VGA Loopback cables are secure.
2. Ensure that your CD-ROM drive or CD are in good condition, e.g. no scratches on CD surface.

**Problem** SBCD gives an error message during bootup even though jumper JP5 and the base I/O address entries of your 3DO Blaster in the AUTOEXEC.BAT and CONFIG.SYS files are set correctly.

**Cause** LPT2 of your system's I/O card is activated.

**Solution** Reconfigure LPT2 to another parallel port (refer to your I/O card's manual) or select another base I/O address for your Creative CD-ROM drive (refer to Chapter 5 and Chapter 3).

---

## Technical Support

We are committed to giving you the best product as well as the best technical support. When you contact us, please have the following information ready:

- Hardware configuration information such as the base I/O address used.
- Error message on the screen and how it came about.
- Information on the adapter card that conflicts with your card.

This section shows where you can contact us:

- Inside U.S.A., Canada and South America
- Inside Europe
- Inside Asia
- Through Compuserve

---

### Inside U.S.A., Canada and South America

CREATIVE LABS, INC. Technical Support

1523 Cimarron Plaza  
Stillwater, OK 74075  
U.S.A.

Tel : (405) 742 6622  
Fax : (405) 742 6633  
BBS : (405) 742 6660

Operating Hours (U.S.A. Central Time)  
Mon-Sun : 8:00 am-12:00 am (16 hours)  
Public Holidays : Closed

---

## Inside Europe

CREATIVE LABS (IRELAND) LTD. Technical Support

Blanchardstown Industrial Park  
Blanchardstown  
Dublin 15  
Ireland

Ireland      Tel    : (353) 1-820-7555  
                 Fax    : (353) 1-820-5052

France        Tel    : (33) 1.39.20.04.21

UK            Tel    : (44) 734-344744  
                 BBS   : (44) 743-360287

Germany      Tel    : (49) 2131-102838  
                 BBS   : (49) 2131-919820

Note: Inside Europe, please direct all faxes to Ireland.

---

## Inside Asia

CREATIVE TECHNOLOGY LTD. Technical Support

Blk 75, #01-04  
Ayer Rajah Crescent  
Singapore 0513

Tel    : (65) 773 4048  
Fax    : (65) 773 0353  
BBS   : (65) 776 2423

Operating Hours (Singapore Time)

Mon-Fri        : 9:00 am-6:00 pm  
Sat             : 9:00 am-1:00 pm  
Sun & Public Holidays : Closed

---

## Through Compuserve

To serve you better, we have created a Creative Labs Forum on Compuserve. Through this forum:

- You will have direct access to our company representatives who will be there to answer your questions.
- You will be part of an interactive community of Creative's product users. Here you can share experiences and ideas and also seek solutions to problems.
- We will also keep you up-to-date on the latest product information, software updates, and fixes to common problems.
- We will also welcome your recommendations and suggestions for new products and for improving our products in future releases.

---

### If you are already a member of Compuserve

To access the forum: type Go Blaster at the Compuserve prompt.

---

### If you are not a member of Compuserve (valid only in U.S.A.)

We have arranged for you to receive a free introductory Compuserve membership which includes:

- one free month of Compuserve's Basic Services,
- a US\$15 introductory usage credit to explore the Creative Forum and Compuserve's other Extended Services,
- a private User ID Number and Password, and
- a complimentary copy of CompuServe Magazine, Compuserve's monthly computing publication.

To receive this special offer:

- Call 1-800-524-3388 and  
Ask for Representative #228.

# D

---

## 3DO Blaster General Specifications

This Appendix contains specifications of your 3DO Blaster.

### Display Specifications

- 32-bit RISC CPU
- 64 million pixels/second animation
- 1 MB VRAM handling up to 16 million colors

### Video Overlay Specifications

- 512K 16-bit video overlay supporting 800 x 600 resolution and 64K colors

### Audio Specifications

- 16-bit digital signal processor for CD quality sound

### Memory Specifications

- 2 MB main RAM
- 1 MB ROM
- 32 KB SRAM with battery backup

### I/O Addressing

- Jumper selectable base I/O addressing at 260H, 270H, 280H, and 290H

## Connectors

### External

- ❑ Two DB-15 connectors for VGA IN/OUT
- ❑ One DB-9 connector for 3DO control pad

### Internal

- ❑ VESA compliant VGA Feature connector
- ❑ CD-ROM bus connector
- ❑ CD-Audio connector to CR-563 CD-ROM drive
- ❑ CD-Audio connector to Sound Blaster
- ❑ FMV daughterboard connector

# Index

## Symbols

### 3DO Blaster

- base I/O address jumper
    - available configurations 5-3
  - changing base I/O address jumper setting 5-3
  - checking factory default 2-1
  - connecting to 3DO control pad 2-8
  - connecting to audio card 2-9
  - connecting to Creative CD-ROM drive 2-6
    - using CD Audio cable 2-7
    - using CD-ROM Data cable 2-6
  - connecting to VGA card 2-10
  - connecting to VGA monitor 2-12
  - inserting into computer 2-4
  - installing 2-1
  - securing in computer 2-5
  - setting environment statement 3-5
  - setting up software 3-1
    - installing VoiceAssist user files 3-4
    - running SETUP.EXE 3-1
    - using 3DO Blaster Configuration utility 3-5
  - specifications D-1
  - uninstalling software 3-7
- ### 3DO Blaster Configuration utility
- explained 3-5
- ### 3DO Blaster Video Overlay Setup
- dialog box A-1
  - using A-2
- ### 3DO control pad
- 2-8, 4-8
- ### 3DO Player
- adjusting volume 4-16
  - changing color key 4-15
  - changing screen modes 4-14
  - components in window 4-2
  - control menu 4-3
  - enlarging to full screen 4-14

- menu bar 4-3
  - player screen 4-3
  - quitting 4-18
  - resizing window 4-13
  - saving a playing title 4-17
  - starting 4-2
  - starting a title 4-7
  - status bar 4-3
  - tool bar 4-6
  - using 3DO control pad 4-8
    - using joystick 4-10
      - calibrating joystick 4-10
  - using keyboard 4-9
    - emulating 3DO control pad 4-9
    - mapping control pad buttons to keys 4-9
  - using Storage Manager 4-17
  - using voice to control 4-11
  - using VoiceAssist 4-11
- ### 3DO Video Overlay Setup
- starting A-1

## A

- Aligning images with 3DO Player window A-2
- AUTOEXEC.BAT file
  - modifications to 3-7

## B

- ### Base I/O address
- available 1-7
  - changing jumper setting 5-3
  - default jumper setting 1-7
  - explained 1-7
  - factory default 1-7
  - I/O address ranges 1-7
  - jumper configurations 5-3



## C

- Cables
  - CD Audio 1-3
  - VGA Feature Connector 1-2
  - VGA Loopback 1-1
- Calibrating joystick 4-10
- CD3DOBLT.SYS
  - explained 3-7
- Color key 4-15
- Compuserve C-3
- CONFIG.SYS file
  - modifications to 3-6
- Connecting
  - VGA card 2-10
  - VGA feature connectors 2-10
  - VGA monitor 2-12
- Connector
  - CD Audio-In 1-4
  - CD Audio-Out 1-4
- Connectors
  - 3DO control port 1-4
  - CD-ROM Data 1-3
  - FMV daughterboard 1-4
  - VGA Feature 1-4
  - VGA In 1-4
  - VGA Out 1-4
- Creative CD-ROM drive
  - checking ID jumper setting 2-6
- CREATIVE LABS (IRELAND) LTD.
  - Address and Phone C-2
- CREATIVE LABS, INC. Address and Phone C-1
- CREATIVE TECHNOLOGY LTD.
  - Address and Phone C-2

## D

- Deleting a saved title 4-18
- Discharging static electricity 2-2

## E

- Emulating with keyboard 4-9
- Environment settings 3-7

## F

- Full screen display 4-14

## H

- Hardware Conflict 2-2, 5-3
- Hi-Color mode
  - changing A-2

## I

- I/O Address Ranges 1-7
- Inserting Card Into Slot 2-4
- Installing
  - Video Blaster RT300 2-2

## J

- Jack
  - VGA input 2-10
  - VGA output 2-10
- JP5 1-7, 5-3
- Jumpers 1-5
  - base I/O address 1-6
  - changing configuration 5-1
  - disabling 1-6
  - enabling 1-5
  - explained 1-5

## L

- Locating Free Expansion Slot 2-3
- LPT2 B-2

## M

- MCI Driver B-1

## P

- Placing jumper block 5-2

## R

- Removing
  - jumper block 5-2
  - metal plate 2-4
  - system's cover 2-3

## S

- Saving a playing title 4-17
- Securing card to slot 2-5
- SETUP.EXE
  - explained 3-4
  - running 3-1
- Software installation path 3-3
- Specifications D-1
- Starting a 3DO title 4-7
- Storage Manager 4-17
- System requirements vi

## U

- Uninstalling software 3-7

## V

- VGA
  - Card, connecting to 2-10
  - Input jack 2-10
  - Monitor, connecting to 2-12
  - Output jack 2-10
- VGA color and resolution B-2
- VGA Sync setting
  - changing A-2
- VoiceAssist user files
  - using 4-11
- Volume
  - adjusting 4-16

## W

- Wall Outlet 2-2